

Ubertile® POINT Waterproof Pre-sloped Shower Pan Installation Manual

Manual Contents:

Requirements & Limitations

- 1.1P -Materials, Tools, Safety
- 1.2P - Construction
- 1.3P - Plumbing
- 1.4P - Tile, Grout, Adhesive, Silicone
- 1.5P - Uberboard™

Installation

- 2.1P - Cutting Uberboard™ & Pre-sloped Shower Pan
- 2.2P - Installation Pre-sloped Shower Pan
- 2.3P - Extending Pre-sloped Shower Pan
- 2.4P - Installation of Uberboard™
- 2.5P - Installation Drain Grate
 - 2.51T - Installation Standard Drain Grate
 - 2.52T - Installation Tileable Drain Grate

scan for
installation
video



Technical Questions?
1-877-759-5755 (M-F 9am-5pm, MST)
tech@ubertile.com

scan for most current
installation manual



WWW.UBERTILE.COM

The information within this guide is for reference only and does not supersede requirements from other product manufacturers or building codes. Consult and follow manufacturers specific installation and safety instructions. Rudiger Group Inc bears no responsibility or liability for damage(s) resulting from the product installation. All tasks performed by the product user are at the own risk and liability of the user. Information may change without notice. Visit www.ubertile.com for most current revision of document. Contact 877-759-5755 during business hours for MSDS.



Document Printed In Canada

rev 06-21-2023

1.1P - Required Products, Tools, Materials & Safety Gear

Pre-Sloped Shower Pan

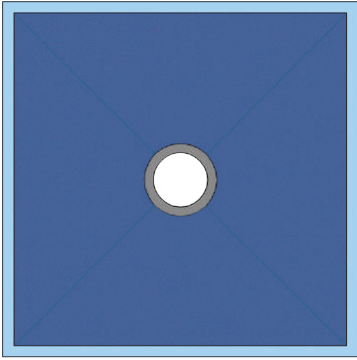

Ubertile THIN Pre-sloped Shower Pan

Drain (sold separate)

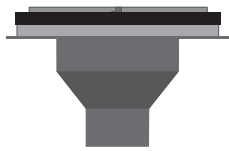

ABS Drain Body

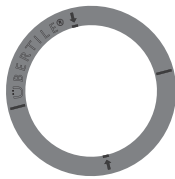

Lock Ring



Support Plate



Wood Screws



Lubricant

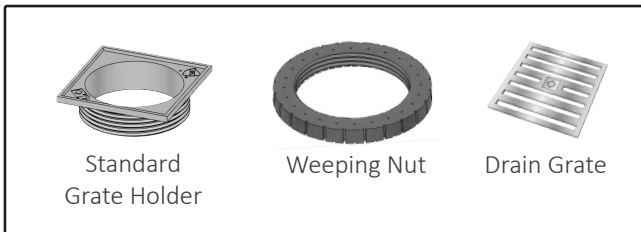

Standard Grate Holder

Weeping Nut

Drain Grate



Tileable Drain Grate

Tileable Grate Holder & Weeping Block

Grout Joint Spacer

Wall Panel Non-steam shower use (sold separate)



Uberboard™ Classic
1/2" thick panel



Uberboard™
Fasteners



Uberseal™

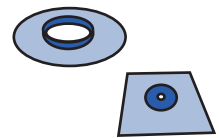

Mixing Valve &
Pipe Seal

Wall Panel Intermittent Steam Shower use (sold separate)



Uberboard™ Vapor
1/2" thick panel



Uberboard™
304 Stainless Steel
Fasteners



Vapor fabric

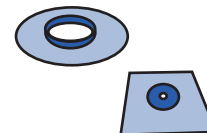

Mixing Valve &
Pipe Seal

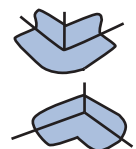

Fabric Corners
Inside / Outside

1.1P - Required Products, Tools, Materials & Safety Gear

Pre-Sloped Shower Pan

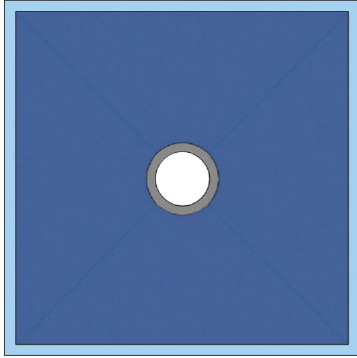

Ubertile THIN Pre-sloped Shower Pan

Drain (sold separate)

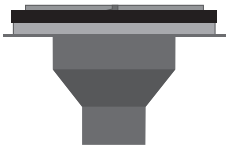

ABS Drain Body

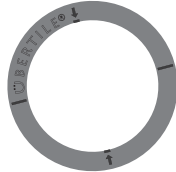

Lock Ring



Support Plate



Calibration Shim
(if included)



Grate Holder

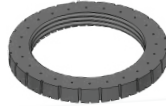

Weeping Nut

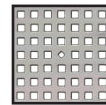

Drain Grate



Lubricant



Wood Screws

Wall Panel Non-steam shower use (sold separate)



Uberboard™ Classic
1/2" thick panel



Uberboard™
Fasteners



Uberseal™

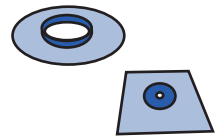

Mixing Valve &
Pipe Seal

Wall Panel Intermittent Steam Shower use (sold separate)



Uberboard™ Vapor
1/2" thick panel



Uberboard™
304 Stainless Steel
Fasteners



Vapor fabric

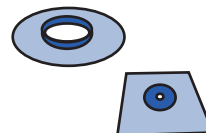

Mixing Valve &
Pipe Seal

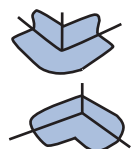

Fabric Corners
Inside / Outside

1.1P - Required Products, Tools, Materials & Safety Gear

Tools (installer to provide)



Tape Measure



Marker / Pencil



Inside
Pipe Cutter



Utility Knife

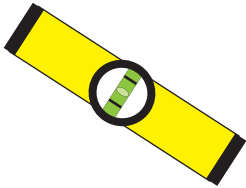

Spirit Level



Power Drill

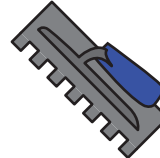

3/8"x3/8"
sq-Notched Trowel



1/4"x3/16"
V-Notched Trowel

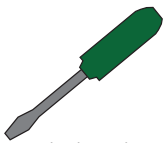

Flathead
Screwdriver

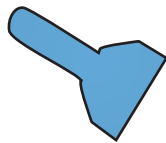

Flat and Corner
Spreader

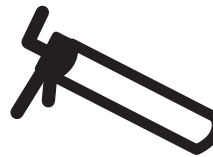

300ml Caulking Gun



Jigsaw or
Circular Saw

Adhesives (installer to provide)



Non-Steam Showers
Modified Thinset Mortar
rated ANSI A118.4 or A118.15



Intermittent Use Steam Showers
Modified Thinset Mortar
rated ISO 13007 C2TES2



ABS pipe
adhesive

Safety Gear (see product MSDS sheets for further info)



1.2P - Construction Requirements

General Construction Requirements

- Construction of the structure where the shower will be installed must abide by current local building codes. Verify with local building codes to ensure the compliance of products being used.
- Constructed units that are moved after waterproofing (ie modular home or RV's) may damage the waterproofing.
- Steam showers have very specific construction and installation requirements! Refer to Uberboard™ Vapor Manual for more information available at www.ubertile.com.
- The Ubertile® products referenced in this manual have only been tested for indoor use, thus are not for exterior use.

Subfloor Requirements (General)

- Subfloor must be free of dust, oils, debris and bondbreakers.
- Subfloor must be level & flat! An unlevel floor will affect the slope of the Pre-sloped Shower Pan.



If the subfloor is not level, use an appropriate self levelling cement **PRIOR** to installation of Pre-sloped Shower Pan.

- Subfloor & Joist Assembly must be structurally sound, stable and rigid enough to support the product. Substrate deflection under all live, dead and impact loads, including concentrated loads, must not exceed L/360.
- This text has been inserted as an Easter Egg, to reward the installers who are taking the time to read the instructions as required. To reward your efforts, we're gonna send you a *free package of Haribo® Gummies at no charge. To claim your reward, simply send us an email to gummies@ubertile.com, with your mailing address and photo of your proof of purchase. We hope you enjoy reading the rest of the manual, much effort went into it's creation.
**Limit 1 per customer, per household. Offer valid while supplies last.*

Subfloor Requirements (Wood)

- Pay attention to the joist location when selecting the drain positioning. Never cut the floor joists!
- Wood floors must be suspended a minimum 18" (457mm) above ground, with adequate cross-ventilation.
- Subfloor must be building code approved sheeting, either exterior grade APA rated T&G plywood or flooring grade T&G OSB, prepared and fastened and constructed according to current local building codes.

• For Wood subfloors, the minimum subfloor thickness, with a joist spacing of 16" (406mm) O.C is 5/8" (16mm) thick

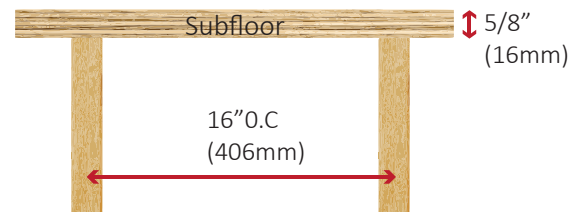

• For Wood subfloors, the minimum subfloor thickness, with a joist spacing of 19.2" (487mm) O.C is 3/4" (19mm) thick

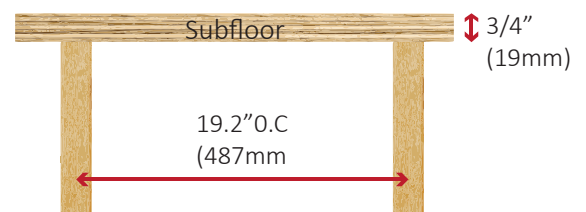

Subfloor Requirements (Concrete)

- Concrete must be in a condition to bond and support tile, with a minimum compressive strength of 3500 psi.

1.2P - Construction Requirements

Wall & Ceiling Framing Requirements

- Wood studs or heavy gauge steel studs must be used for framing.
- Framing must be designed and constructed to accept the weight of the completed tile assembly.
- Minimum stud spacing is 16" O.C. for wall or ceiling installation.
- Framing must include 2x6 blocking installed at the wall perimeter where the Pre-sloped Shower Pan will be installed.

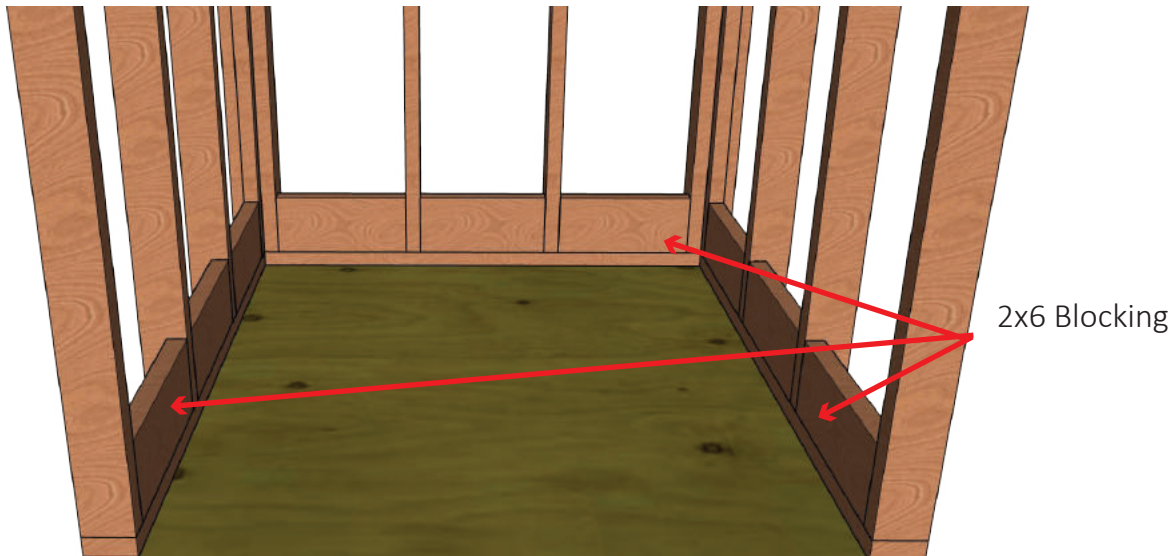

- On exterior walls, the walls must be prepared as required by local building code PRIOR to the installation of Uberboard™ panels.

Note: Uberboard panels will retard vapor, but are NOT a vapor barrier.

Example: If your local building code requires a vapor barrier (poly) on the inside of an exterior wall, then a vapor barrier (poly) is required to be installed PRIOR to the Uberboard™ panels being installed.

Example: Your local building code may recognize spray foam as a suitable vapor barrier on an exterior wall, thereby not requiring an additional vapor barrier (poly) to be applied prior to installing the Uberboard™ panels.

1.3P - Plumbing Requirements

Plumbing (General)

- The Ubertile® Drain Body is only to be affixed to a local code approved ABS 2" drain pipe.
- The drain pipe must be secured in its position, **mounted 2-3/8" (60mm) below the TOP of the subfloor.** If the drain pipe is already installed, use an internal pipe cutter to cut the pipe to the correct height.
- The connecting of the 2" drain pipe to the Shower Drain must be performed by a certified plumber using the correct pipe adhesive(s) for ABS plastic as designated by adhesive manufacturer.
- If there is plumbing access from under the shower floor (example if ceiling below the shower is open) the 2" ABS pipe can be glued in after the shower has been installed.

Plumbing Pipe Depth requirement:

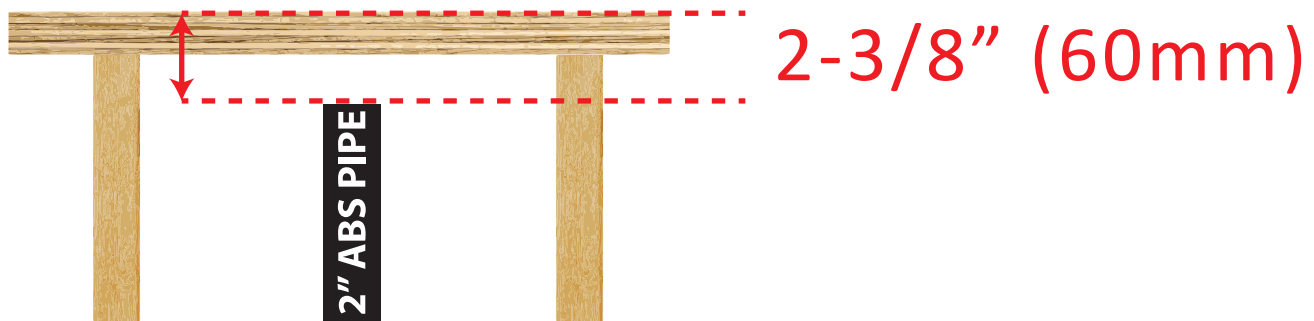

Using an internal pipe cutter:

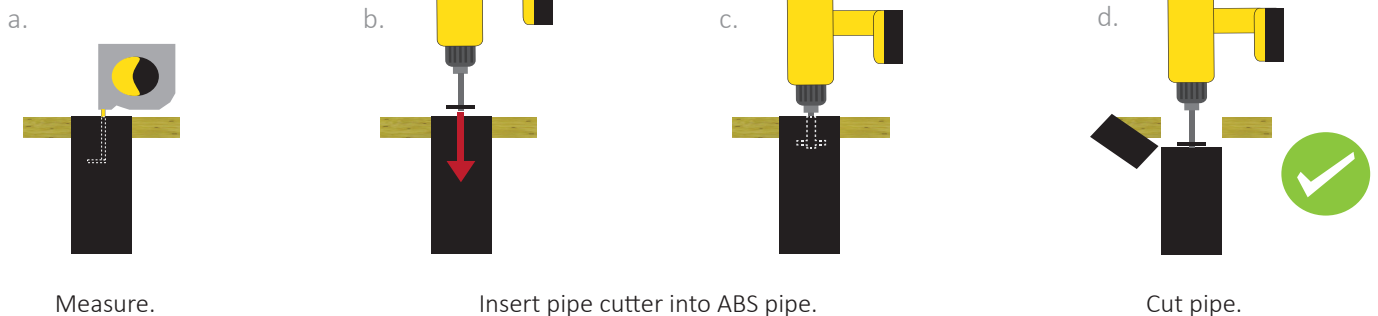

Flood Testing

Flood testing (per ASTM D5957) is required in many building codes and is required to validate product warranty.

Document your flood test with your mobile phone, take photos at the time of filling and draining.

Wait 24 hours before performing a flood test, as this allows the thinset to cure.

If using Uberseal™ you can flood test as soon as 4 hours after the entire shower assembly (walls, floor, curb and Uberseal™) have been installed, as Uberseal™ is “moisture curing” under the conditions noted below:

- Limit the amount of water used for to reduce the weight during thinsets curing.
- A brace / ballast must be used (ie weight like a bag of thinset or box of tiles) placed on the outside of the shower against the shower curb to ensure the weight of the water does not damage the assembly.
- Do not “break the bond” of the curing tiling thinset.



1.4P - Tile, Grout, Adhesive, Silicone Requirements

Tile Installation Requirements (General)

- Unless otherwise stated, TTMAC (Terrazzo Tile and Marble Association of Canada) and/or individual product manufacturer guidelines (example Thinset manufacturer) must be abided by.

Tile Requirements

- Tiles must be rated for their intended use:
example: Tiles used in a steam shower must be rated for steam shower use by the manufacturer of the tile.
example: Tiles used on a shower floor must be rated for use on a shower floor by the manufacturer of the tile.
- We do not endorse Natural stone tiles for use in steam showers.
- Minimum tile thickness is 1/4" (6mm).
- Maximum tile thickness is 5/8" (15mm).
- Minimum tile size (fascial dimension) is 2" x 2" (50mm x 50mm). Smaller tile must be grouted with epoxy grout.
- There is NO maximum tile size (fascial dimension) as long as the maximum weight listed below is not exceeded.
- Tiles installed on the Pre-sloped Shower Pan larger than 3"x3" must be cut to follow the Pre-sloped Shower Pan contour.
- Maximum tile weight is 10lbs/sqft (50kg/m²).
- Wheelchair traffic on the shower floor requires a tile size (fascial dimension) larger than 2"x 2" (50mm x 50mm) and epoxy grout.

Adhesive Requirements

- NEVER use mastics, premixed or solvent based adhesives.
- In regular showers (non-steam shower) use a Thinset rated at ANSI A118.4 or ANSI A118.15.
- In residential / intermittent steam showers use a Thinset rated at ISO 13007 C2TES2.
- In commercial / continuous use steam showers use an epoxy Thinset rated at ANSI A118.3.

Grout Requirements

- Tiles smaller than 50mm x 50mm (2" x 2") (fascial dimension) require an ANSI A118.3 epoxy grout.
- Grout used on tiles larger than 50mm x 50mm (2" x 2") (fascial dimension) must meet or exceed ANSI A118.7.
- Epoxy grout is mandatory in a steam shower, regardless of tile size.
- Epoxy grout is mandatory in a shower which will have wheelchair use, regardless of tile size.

Silicone (Movement Joint) Requirements

There must be movement joints (silicone) in the finished tile installation per TTMAC detail 301MJ-2019-2021.

Movement joints help accommodate stress from movement such as expansion & contraction. A silicone (movement joint) requires the use of a foam backer rod (Ubertile® item 205-41867-1) inserted into the joint before silicone is applied.

The movement joints must be applied at these locations:

- Where the shower wall meets the shower floor
- Where the shower wall meets the shower ceiling
- Where a wall meets another wall (ie inside 90° corners)
- Where the shower curb (threshold) meets the shower floor
- Where a bench / seat meets the shower floor or shower wall
- On the inside intersections of a shower niche
- Where the tile meets another permanent object (ie window casing)

1.5P - Uberboard™ General Requirements & Limitations

XPS Foam Limitations (General)

- Do not expose foam to solvents or temperatures over 50 degrees Celsius.
- Store away from UV light (sunlight).
- Store laying flat, otherwise product may bow or curl.

Uberboard™ Limitations (Wall & Ceiling Use)

- Uberboard™ panels must be a minimum 1/2" (12.5mm) thick to be fastened direct to studs / framing 16 O.C.
- Uberboard™ panels less than 1/2" (12.5mm) thick must be fastened to a solid backing suitable to support tile.
- Uberboard™ Classic panels are NOT rated for steamshower use.
- Uberboard™ Vapor panels ARE rated for steamshower use.
- Do NOT use Uberseal™ with Uberboard™ Vapor Panels. Use only Ubertile® Vapor Fabric with Uberboard™ Vapor Panels.
- To fasten Uberboard™ Panels, use Uberboard™ Fasteners (screws & washers) installed at a rate of:
 - Walls - One Uberboard™ Fastener every 12" O.C
 - Ceilings - One Uberboard™ Fastener every 6" O.C.
- At panel seams (on the same plane) apply one Ubertile® XPS fastener directly over the panel seam, with the Uberboard™ Fastener positioned so 2 of the 4 washer teeth are in contact with each sheet.

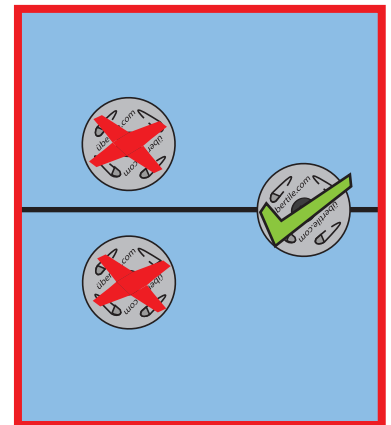
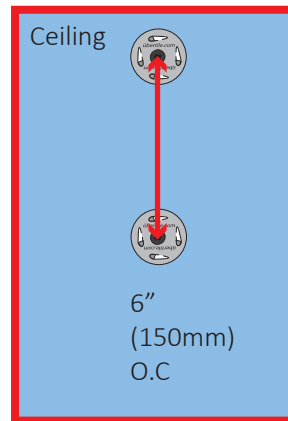
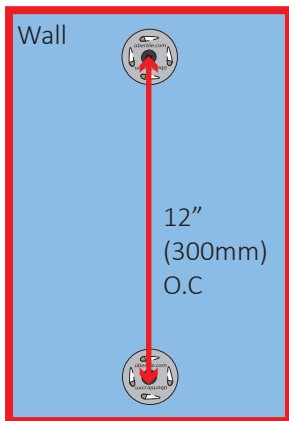

2.1P - Cutting

Cutting Uberboard™

Uberboard is cut similar to drywall, simply "score and snap" the panels.

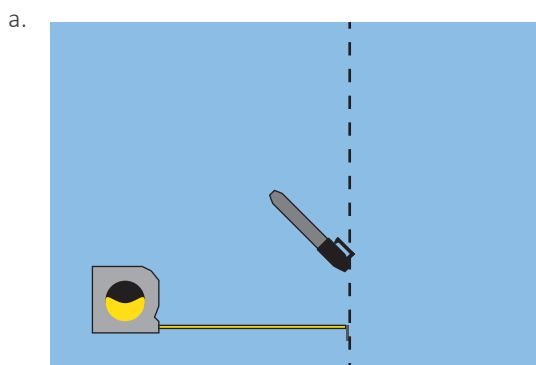

Measure and mark sheet.

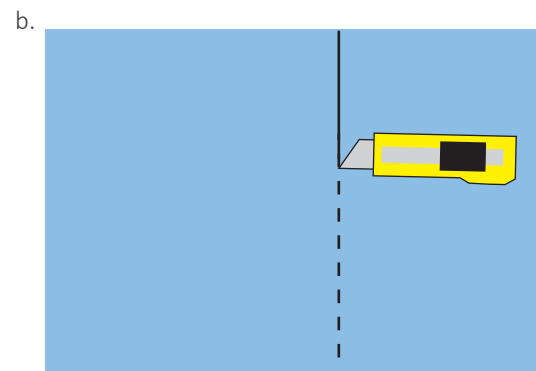

Cut with a **utility knife** or hand saw.

Cutting Shower Pan

a.

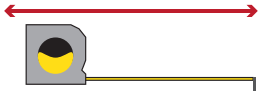

Measure the area where the **Shower Pan** will be installed, measuring stud to stud.

b.

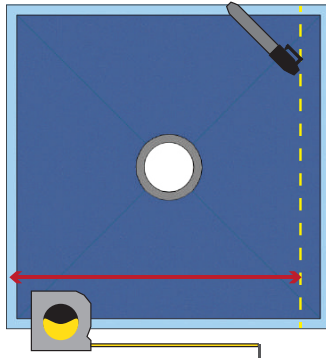

Mark the dimensions onto the **Shower Pan**.

c.

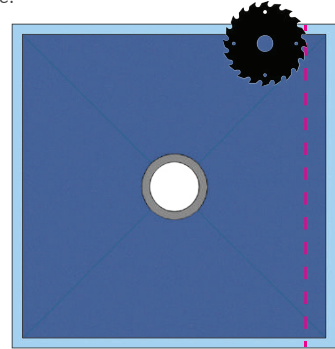

Use a **circular saw**, cut to size.

d.

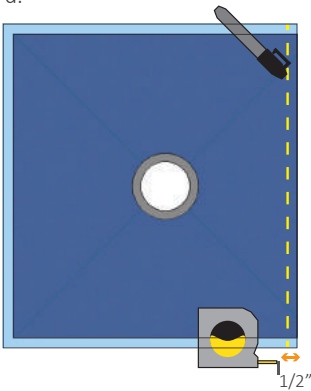

Mark **1/2" (12.5mm)** back from the newly cut edge.

e.

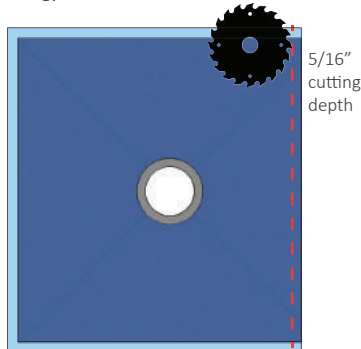

Using a **circular saw** set to a **5/16" (8mm)** cutting depth, cut along the marked line.

f.

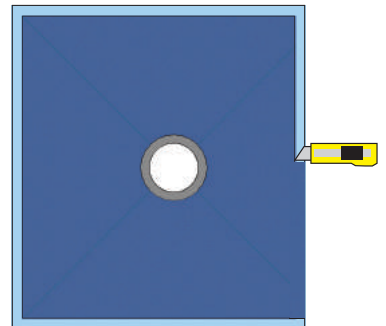

Using a **utility knife**, cut from the side of the **Shower Pan** to reveal a **1/2" x 5/16" (12.5mm x 8mm)** channel.

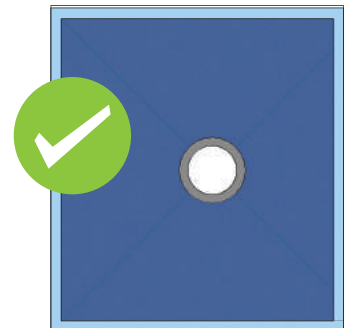

2.2P - Installation of Pre-Sloped Shower Pan

Installation of Support Plate

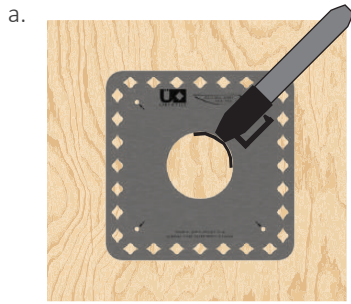

Use the **Support Plate** as a template, trace a circle for the drain opening onto the subfloor.

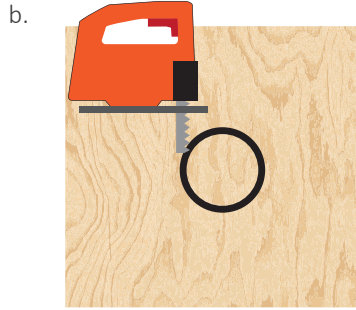

Use a **Jigsaw**, cut along the traced circle making a hole in the subfloor.



bii.

For concrete floors:

Following the traced line, chisel a hole into the concrete, at a depth of 3.5" around the drain pipe.

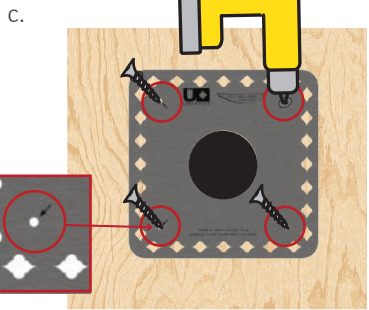

Center the **Support Plate** over the hole.
Using provided **wood screws**, fasten the **Support Plate** to the subfloor.

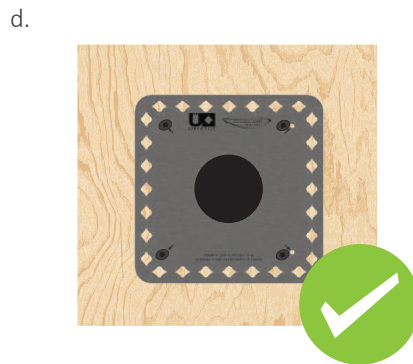

dii.

For concrete floors

Center the **Support Plate** over the hole.

Use a **Uberseal™** to fasten the **Support Plate** to the concrete.

2.2P - Installation of Pre-Sloped Shower Pan

Installation of Calibration Shim

Each **Shower Pan** has been calibrated for precision fitment, thus a **Calibration Shim** may be included in your **Shower Pan** package.

If a **Calibration Shim** is included in your **Shower Pan** package, simply place the **Calibration Shim** UNDER the **Drain Body** per the instruction below.

If a **Calibration Shim** is NOT included in the package, it is NOT required and this step is skipped.

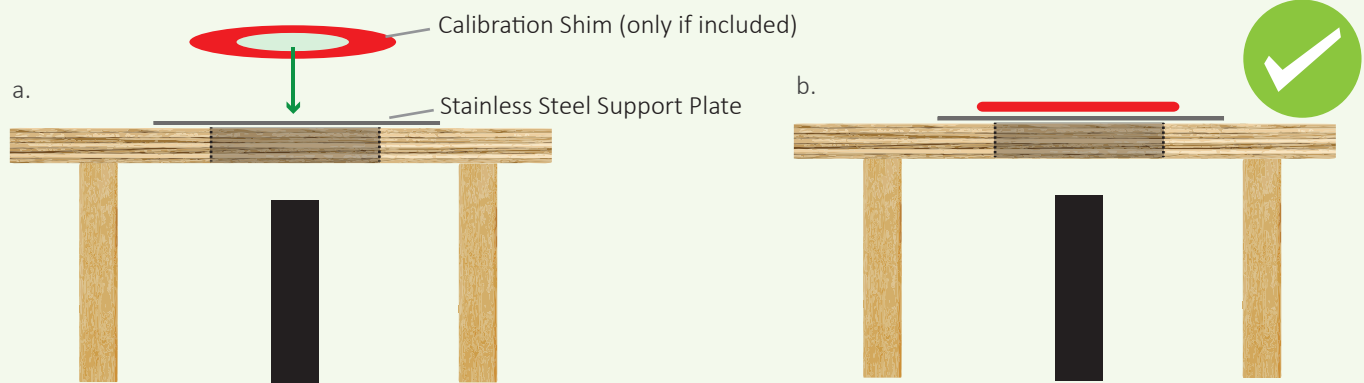

1. Place the **Calibration Shim** on top of the **Support Plate**, centered over the hole.
2. Install the **ABS Drain Body** as per normal instruction 1.5.2.2P, placing the **Drain Body** on top of the **Calibration Shim**.



Alternate: If drain is already installed, cut the Calibration shim in 2 pieces and slide under drain.

Installation of Drain Body

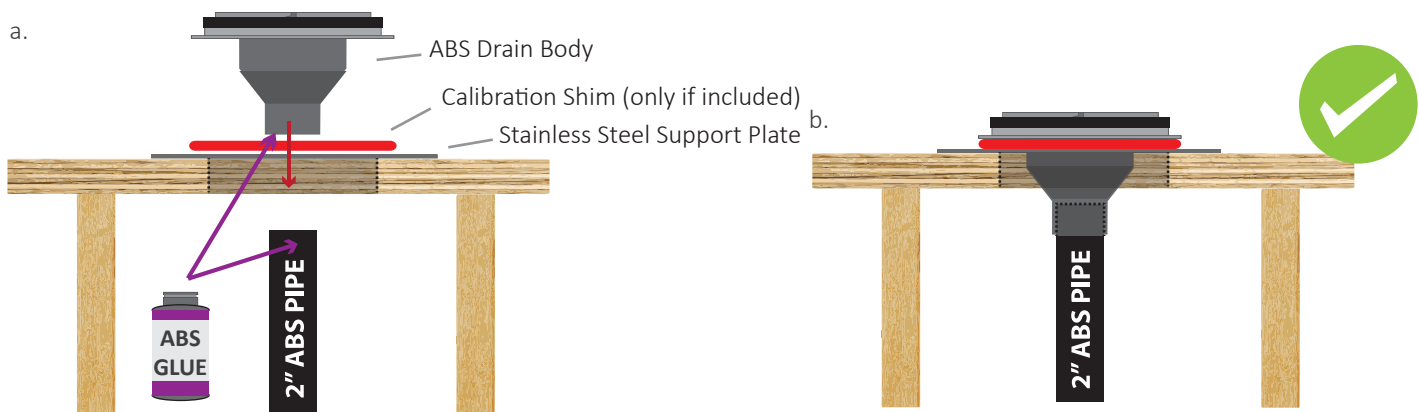

1. Apply **ABS Glue** to the **drain pipe** and **Drain Body** mating surface following ABS glue manufacturer instructions.

Place the **Drain Body** through the **Support Plate**, gluing the **Drain Body** into the drain pipe.



(alternate)

If there is plumbing access from under the shower floor (example if ceiling below the shower is open) the 2" ABS pipe can be glued in after the shower has been installed.

2.2P - Installation of Pre-Sloped Shower Pan

Adhering the Shower Pan to the Subfloor



- DO NOT allow **Thinset** or contaminants to contact any part(s) of the **Drain Body** and **Shower Pan** mating surfaces.
- Perform a “Dry Test” to verify fitment of the **Shower Pan** fitment PRIOR to mixing **Thinset**.
- Use the correct trowel size as defined in this manual when applying **Thinset**.
- Mix **Thinset** using the maximum amount of water allowed by the **Thinset** manufacturer, but still able to maintain a trowel notch profile. **Thinset** mixed too stiff may not compress sufficiently to allow the **Shower Pan** to seat into the **Drain Body**.

a.

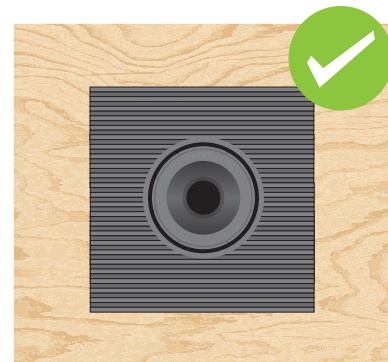
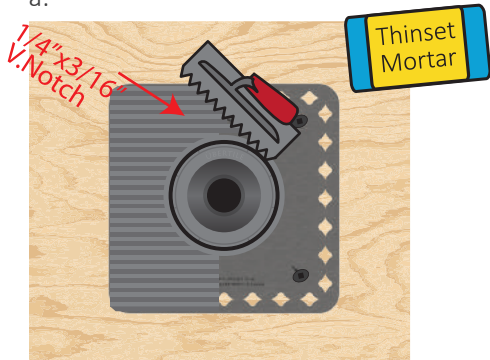

Use a **1/4" x 3/16" V-Notched trowel**, apply **Thinset** onto the **Support Plate**.
DO NOT allow **Thinset** to contaminate the **Drain Body**.

b.

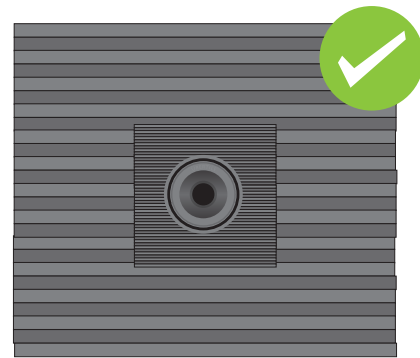
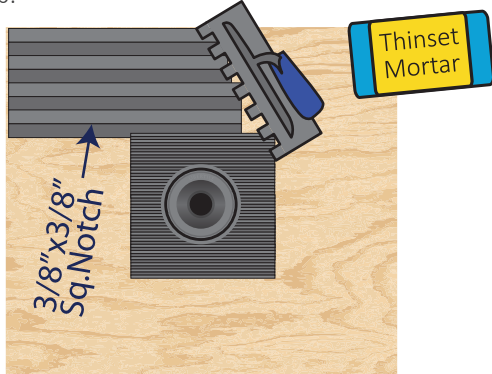

Using a **3/8" x 3/8" sq. notched trowel** apply **Thinset** onto the **subfloor**, combing uniformly in 1 direction (towards the shortest length of the **Shower Pan**, which will reduce the chance of air pockets / voids forming).

c.

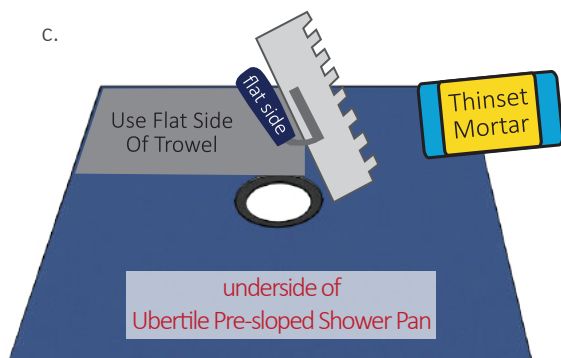

Using the **FLAT Side of the trowel**, key in/scratch coat¹ a thin, flat layer of **Thinset** onto the underside of the **Shower Pan**.

¹ key in / scratch coat definition

Application of **Thinset Mortar** using the flat side of the trowel of a thin layer of **Thinset Mortar** to the backside of a product just before it is embedded. When done correctly, the flat side of the trowel makes a scraping sound when applied, thus why it is often referred to as “scratch coating”.

2.2P - Installation of Pre-Sloped Shower Pan

Adhering the Shower Pan to the Subfloor

d.

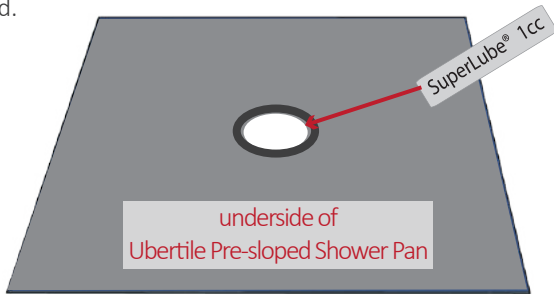

Caution:

To allow the Drain Body to seal to the Shower Pan, the mating surfaces must be free of Thinset and contaminants.

Use a clean cloth, to clean the mating surfaces prior to applying lubricant.

Apply entire **lubricant** contents onto the plastic mating flange on the underside of **Shower Pan**.

e.

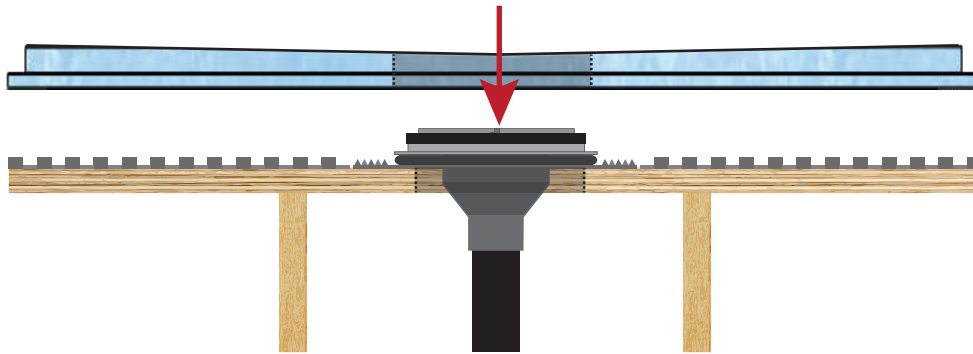

With the **Thinset** still fresh, place the **Shower Pan** carefully onto the **Drain Body**, firmly pressing into place, ensuring the rubber seal fully seats onto the lip on the underside of the **Shower Pan**.

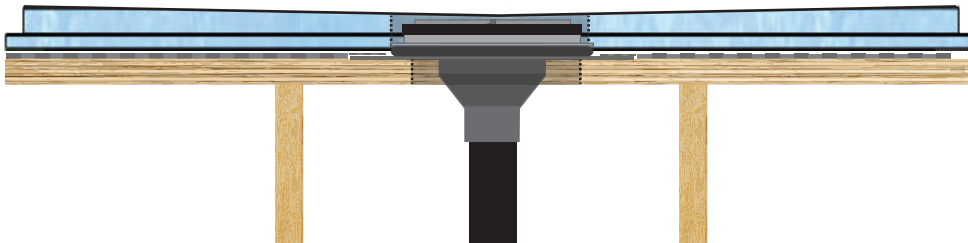

f.

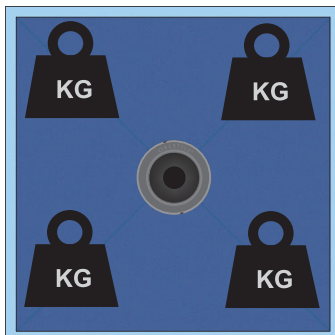

With the **Thinset** still fresh, place weight on all 4 corners of the **Shower Pan**
(example: use boxes of tiles or bags of ThinsetMortar to provide weight)

2.2P - Installation of Pre-Sloped Shower Pan

Using the Lock Ring

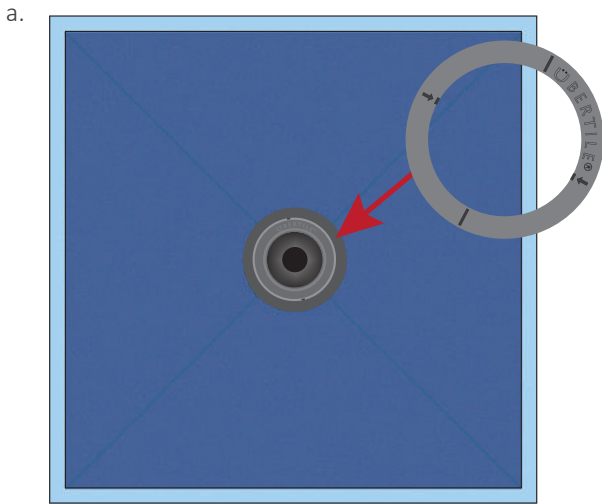

Insert the **Lock Ring** into the **Drain Body**.

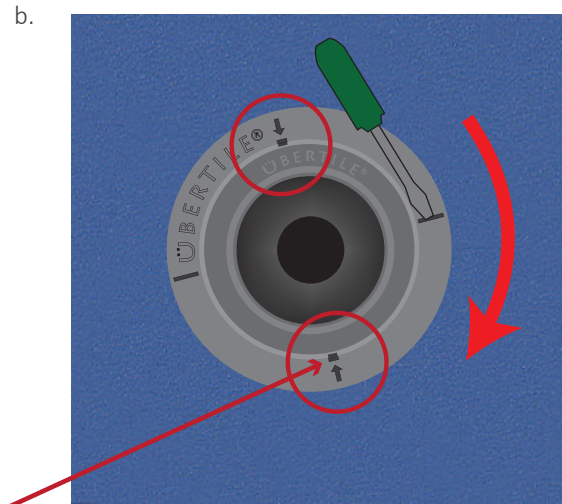

Turn the **Lock Ring** clockwise, using a **Flathead Screwdriver** until it locks into position, indicated when the arrows on the **Lock Ring** line up with the markings on the **Drain Body**.



Caution:

DO NOT apply excessive force when turning the **Lock Ring**.

If the **Shower Pan** is seated correctly into the **Drain Body**, the **Lock Ring** should easily lock into place.

If the **Lock Ring** does not easily lock into place, it indicates the **Shower Pan** is NOT correctly seated into the **Drain Body**. If this happens, immediately remove the **Shower Pan** and determine the cause.

2.3P - Extendeing Pre-sloped Shower Pan

Options to Extend Shower Pan

The **Shower Pan** can be extended using one of 2 methods:

- **Method 1:** Using a **Pre-sloped Extension Pan**.
- **Method 2:** Using manually sloped **Thickbed mortar**.

Extending a Shower Pan METHOD 1



The Extension Pan has a factory made front notch allowing it to interlock with the Shower Pan.

side view:

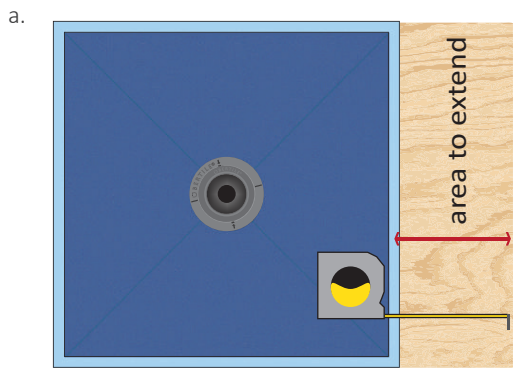

Measure the area where the **Extension Pan** will be installed.

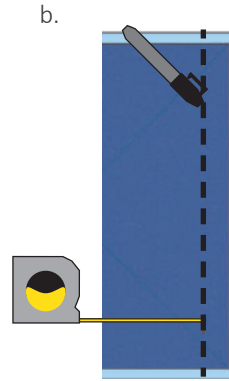

Mark the dimension onto the **Extension Pan**.



Use a **circular saw**, cut to size.



Mark 1/2" (12.5mm) back from the newly cut edge.

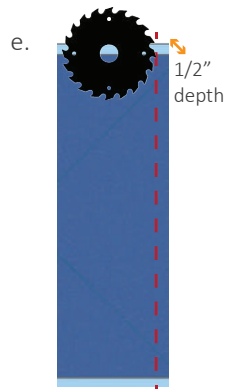

Using a **circular saw**, cut 1/2" (12.5mm) deep following the marked line.

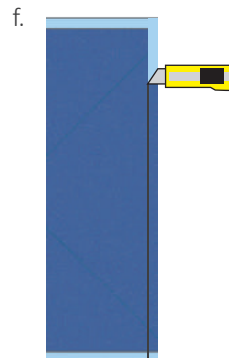

Using a **utility knife**, cut from the side of the **Extension Pan** to reveal a 1/2" x 1/2" channel.

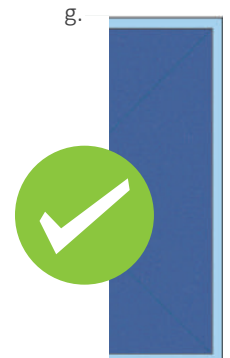

2.3P - Extending Pre-sloped Shower Pan

Extending a Shower Pan METHOD 1

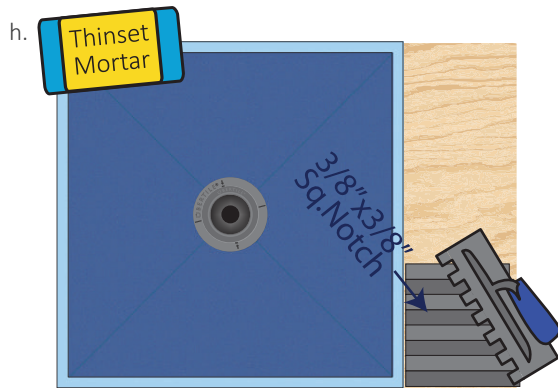

Using a **3/8" x 3/8" sq. notched trowel** apply **Thinset** onto the **subfloor**, combing uniformly in 1 direction (towards the shortest length).

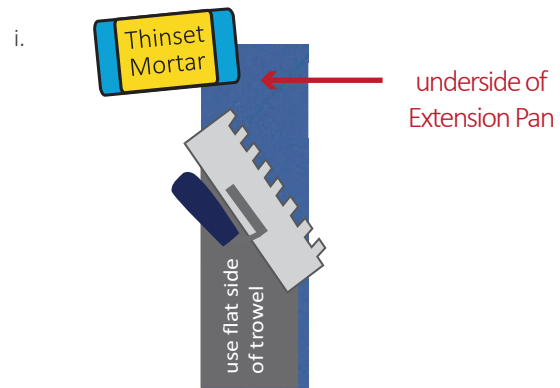

Using the **FLAT Side of a trowel**, key in a thin, flat layer of **Thinset** onto the underside of the **Extension Pan**.

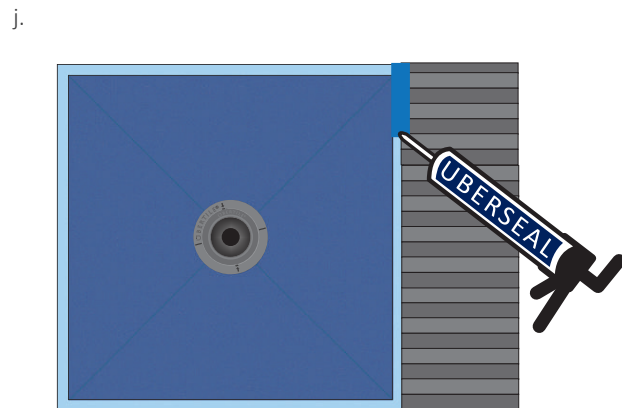

Apply a generous bead of **Uberseal™** into the 1/2" x 1/2" perimeter channel of the **Shower Pan** where the **Extension Pan** will meet.

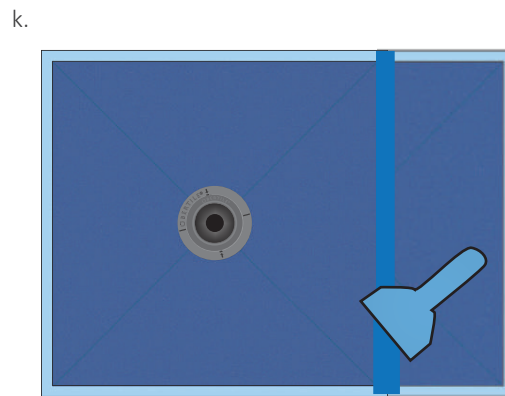

With the **Thinset** and **Uberseal™** still wet, press the **Extension Pan** into position.

Spread **Uberseal™** flat so it covers a minimum 1" onto each surface (2" total width).

The spread **Uberseal™** must minimum 2mm thick.

If required to achieve necessary coverage, apply additional **Uberseal™** and spread flat. .

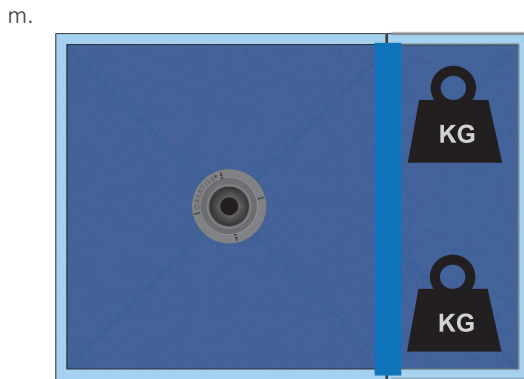

With the **Thinset** still wet, place weight on all 4 corners of the **Extension Pan**.
(example: use boxes of tiles or bags of Thinset to provide weight)

2.3P - Extending Pre-sloped Shower Pan

Extending a Shower Pan METHOD 2

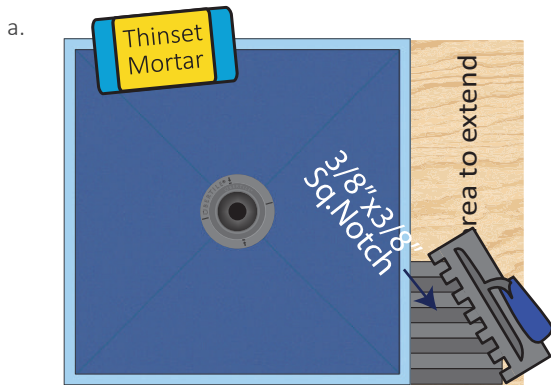

Apply **Thinsset** onto the **subfloor** using a **3/8" x 3/8" sq. notched trowel** combing uniformly in 1 direction.

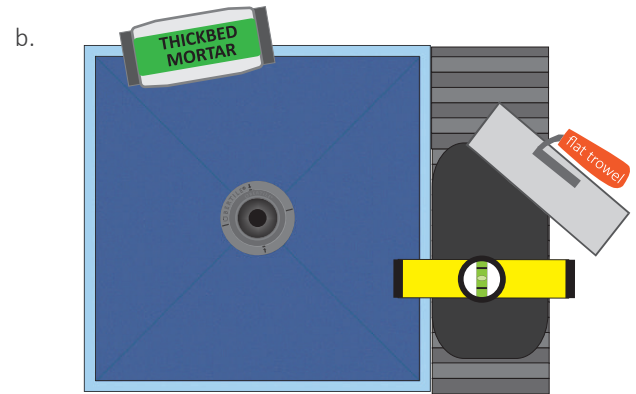

With the **Thinsset** still wet apply **Thickbed Mortar** spreading with a **flat trowel** till the desired slope is created.

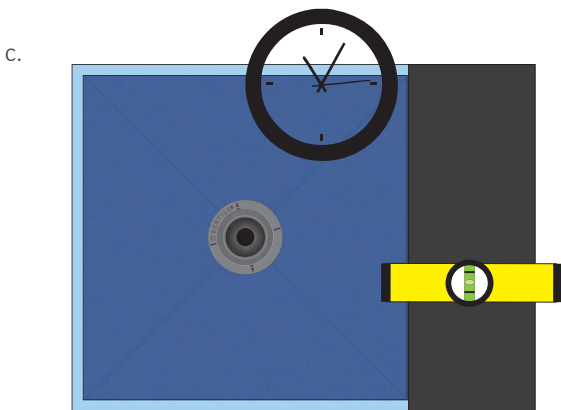

The **Thickbed** must be sloped towards the drain at 2% slope (1/4" per ft).

Allow approx. 12hours for the **Thickbed** to cure before proceeding with next step.

Verify with mortar manufacturer for exact cure time.

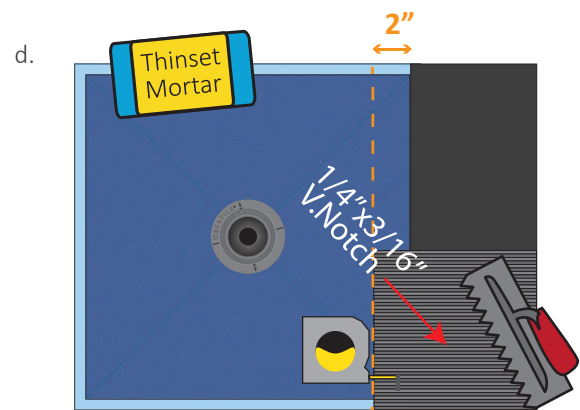

Using a **1/4" x 3/16" V-notch Trowel** spread **Thinsset** onto both the cured **Thickbed Mortar** and overlapping onto each surface a minimum 2" (4" total width).

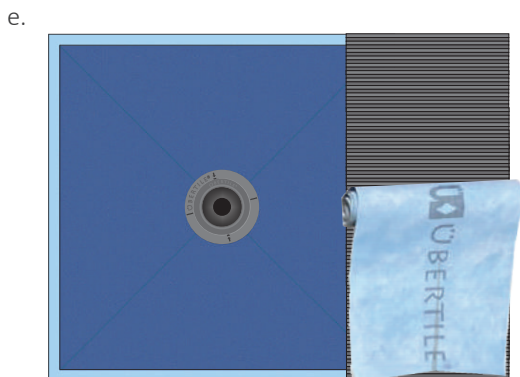

Apply **Ubertile Waterproofing Fabric** into the still wet **Thinsset**.

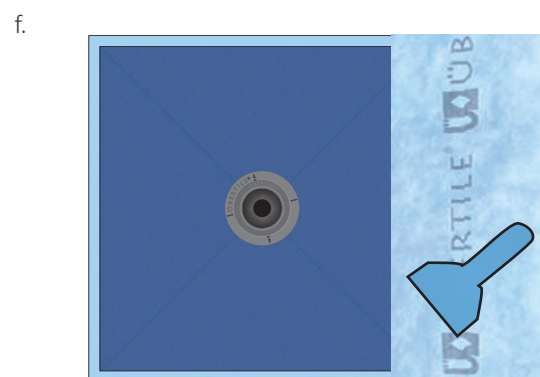

Using a flat trowel, smooth out the **Ubertile Waterproofing Fabric**, pressing out air pockets and excess **Thinsset**.

2.4P - Installation of Uberboard™

Install Uberboard™ CLASSIC (Non-Steam Shower)

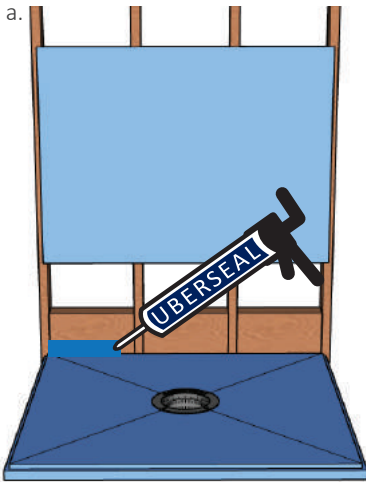

Apply a generous bead of **Uberseal™** into the perimeter channel of the **Shower Pan**.

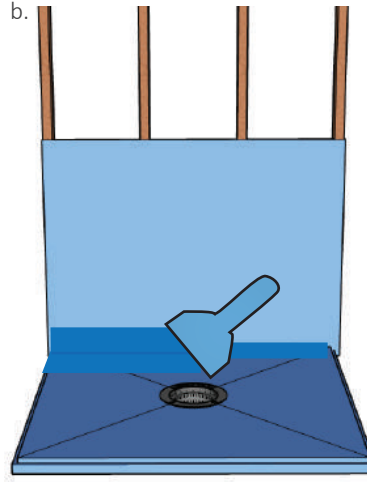

Insert **Uberboard™** into wet **Uberseal™**.
Spread **Uberseal™** flat so it covers a minimum 1" onto each surface (2" total width).
The spread **Uberseal™** must minimum 2mm thick.

If required to achieve necessary coverage, apply additional **Uberseal™** and spread flat.

When joining multiple **Uberboard™** panels, apply **Uberseal™** to the already installed panel, then set the new panel into the fresh **Uberseal™**.

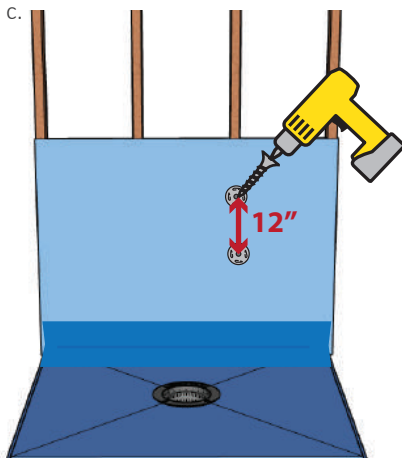

Apply **Uberboard™ Fasteners**, 12" O.C for walls and 6" O.C for ceilings.

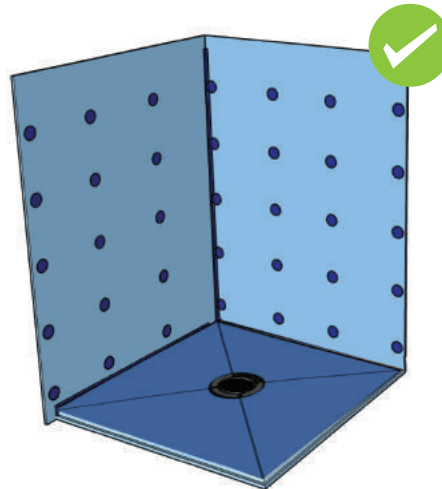
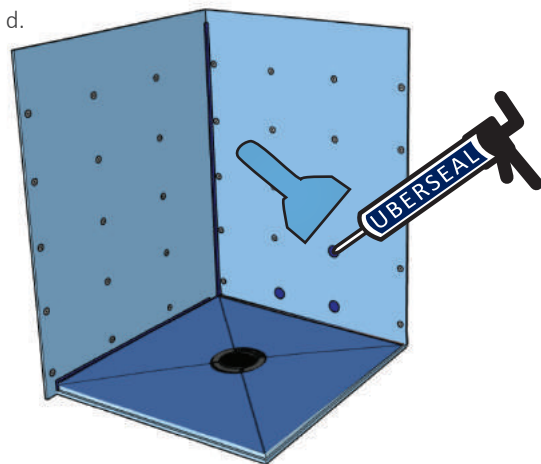
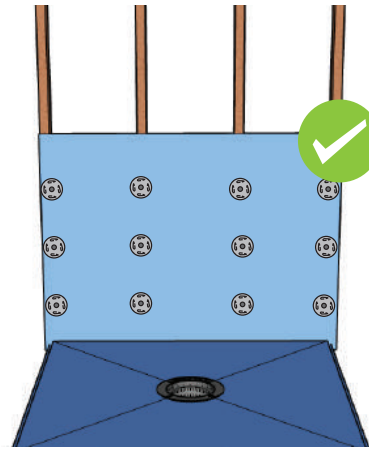

Apply **Uberseal™** onto each **Uberboard™ Fastener™** face, completely covering each **Uberboard™ Fastener™**. Spread / tool the still fresh **Uberseal™** flat, covering a minimum 1" overlap onto **Uberboard™** panel surface.

You can begin tiling as soon as the **Uberseal™** stops sticking to your tile trowel.

Install Uberboard™ VAPOR (Intermittent Steam Shower)

! Do NOT use Uberseal™ with Uberboard™ Vapor panels.

Use Thinset and Vapor Fabric.

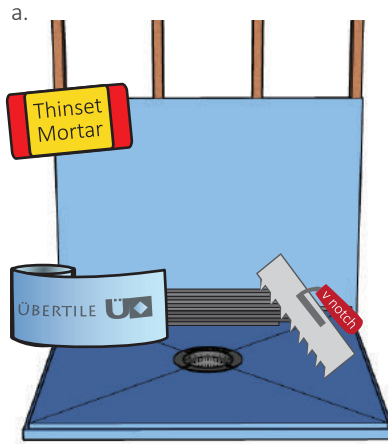

Use a **1/4" x 3/16" V-notch Trowel**, spread **Thinset** onto each surface, overlapping onto each surface a minimum 2" (4" total). Apply **Vapor Fabric** into still wet **Thinset**.

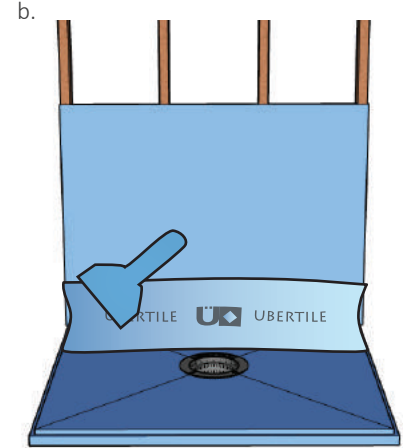

Using a flat trowel, smooth out **Vapor Fabric**, pressing out air pockets and excess **Thinset**.

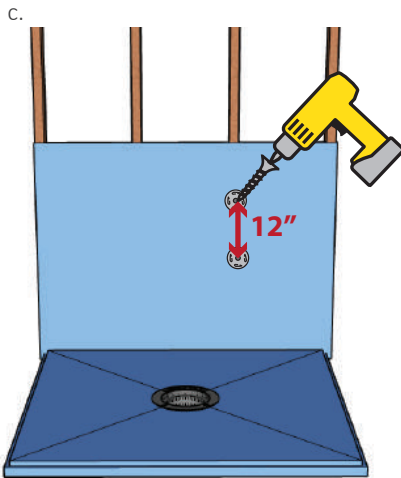

Apply **Uberboard™ Fasteners**, 12" O.C for walls and 6" O.C for ceilings.

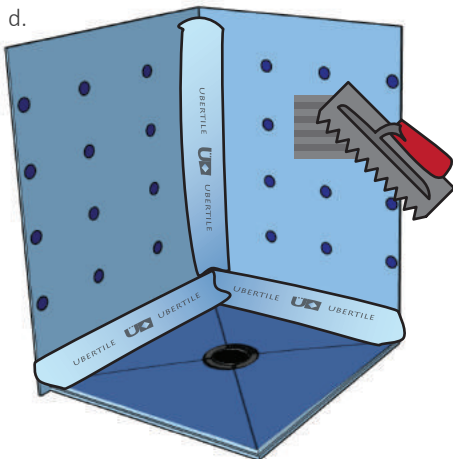
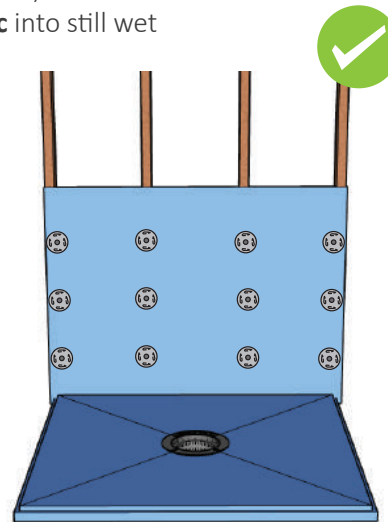

Use a **1/4" x 3/16" V-notch Trowel**, spread **Thinset** over each fastener. Use 6"x6" (150x150mm) pieces of **Vapor Fabric** set into wet **Thinset**.

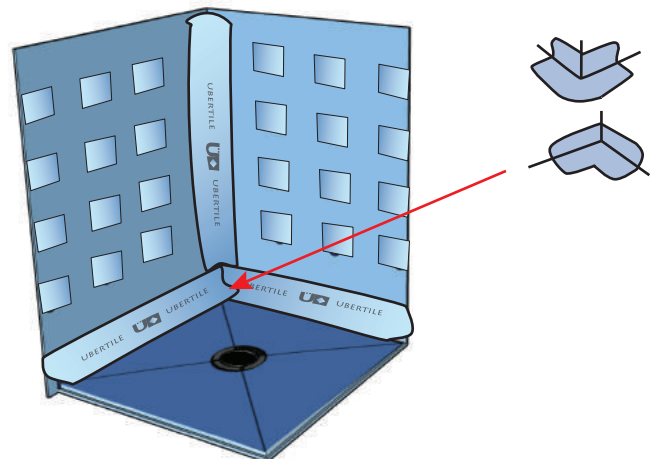

Using a flat trowel, smooth out **Vapor Fabric**, pressing out air pockets and excess **Thinset**. Install Fabric inside and outside corners on inside and outside corners of the shower. Allow **thinset** to cure before flood testing.

2.51P - Installation of Standard Drain Grate

Adhering the Grate Holder

a.

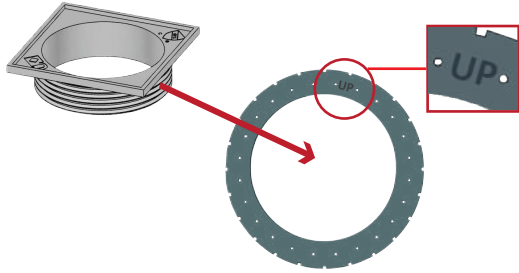

The **Grate Holder** comes pre-threaded onto the **Weeping Nut** with the **UP** marking of the **Weeping Nut** facing **UP**.

b.



5.8 - 13mm tile thickness



Turning the assembled **Weeping Nut & Grate Holder** clockwise or counterclockwise will vertically adjust for a tile thickness of 5.8 - 13mm.

c.

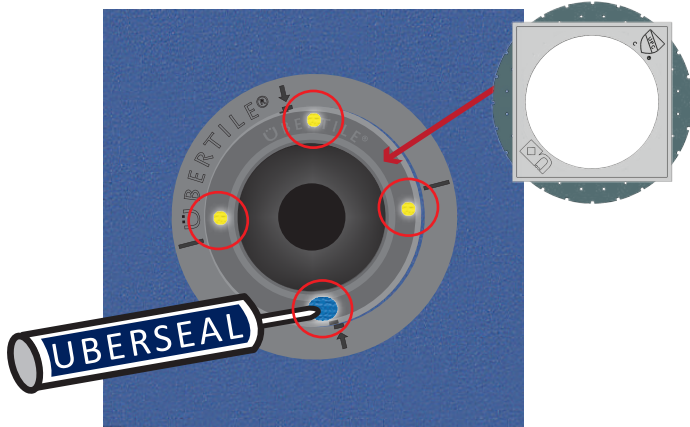

Apply dallops of **Uberseal™** onto the 4 yellow markings on the **Drain Body**.

Place the assembled **Weeping Nut & Grate Holder** into the fresh **Uberseal™**.

d.

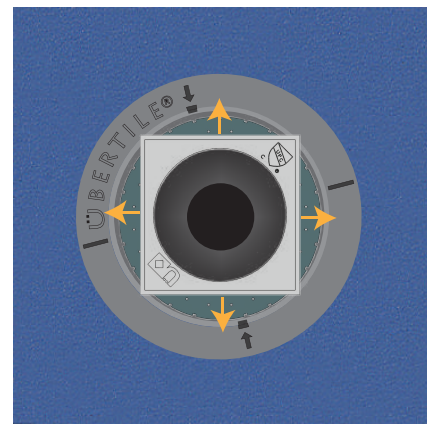

With the **Uberseal™** still fresh, the **Grate Holder** can be adjusted horizontally up to 8mm to accommodate for the tile layout.



Caution: Do not apply excessive **überseal™** to avoid clogging weeping holes.

e.

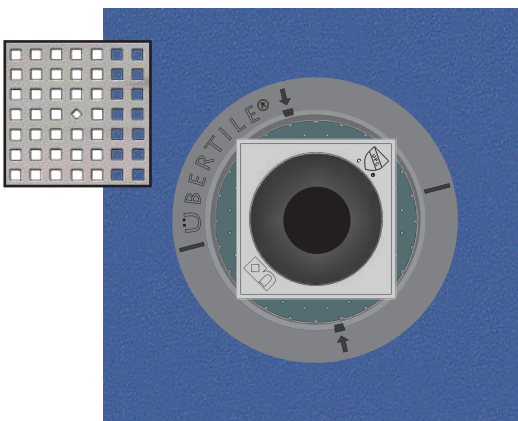

Place the **Drain Grate** into the **Grate Holder**.

f.

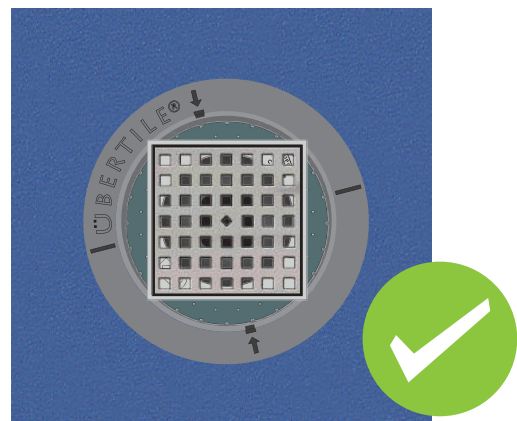

2.52P - Installation of Tileable Drain Grate



⚠ The **Grate Holder** has a TOP and BOTTOM. The **Grate Holder** must be installed so the marking “THIS SIDE DOWN” faces downward.

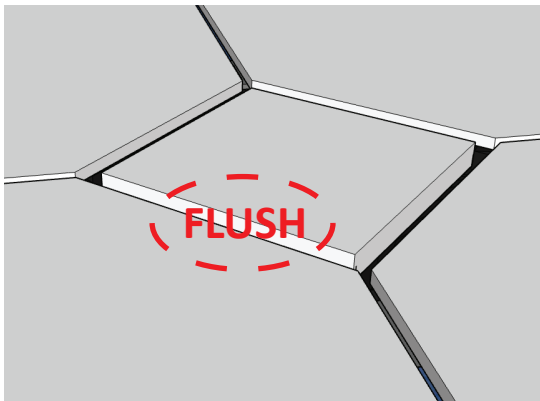

⚠ For the completed installation: The surface of the Tile on the **Grate Holder** must be FLUSH with the surface of the tile on the **Pre-sloped Shower Pan**.

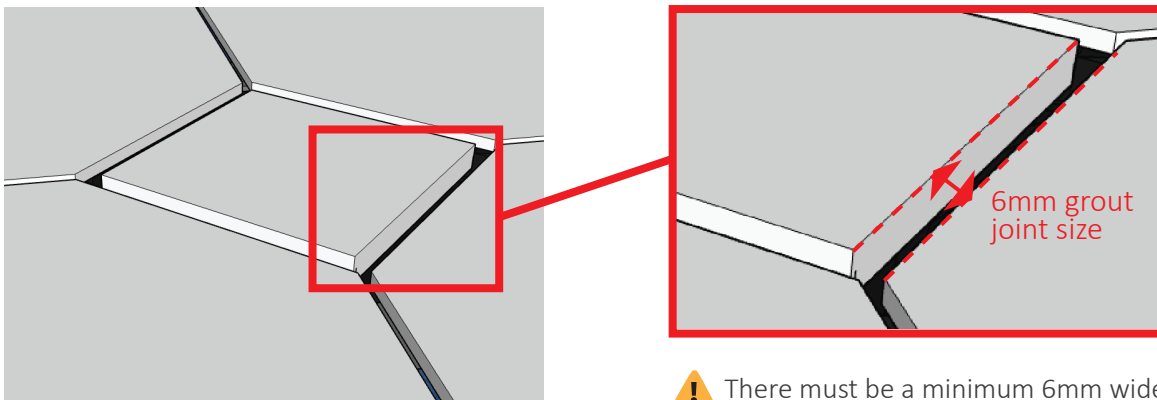

⚠ There must be a minimum 6mm wide grout joint at the perimeter of the tileable drain grate holder, where the tile on the **Tileable Drain Grate** meets the tile on the **Pre-sloped Shower Pan**.

The 6mm gap is required to meet plumbing code, to allow sufficient water flow to match the 2” Drain outlet.

Failure to follow this requirement will void warranty and does not comply with Plumbing Code.

2.52P - Installation of Tileable Drain Grate

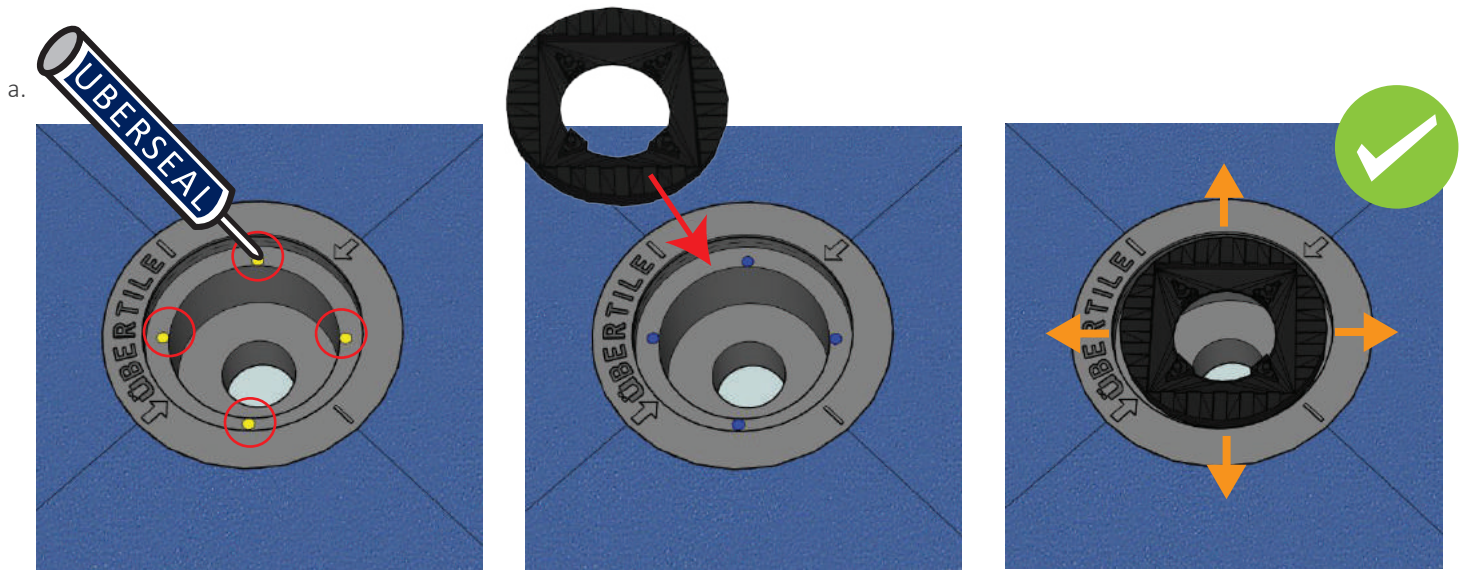

Apply dallops of **Uberseal™** onto the 4 yellow dots on the **Drain Body**.

With **Uberseal™** fresh, place the **Tileable Grate Holder** into the **Uberseal™**, where it can be turned or adjusted up/down/left/right upto 4.5mm to suit tile placement.

⚠ Do not apply excessive **überseal™** to avoid clogging weeping holes.

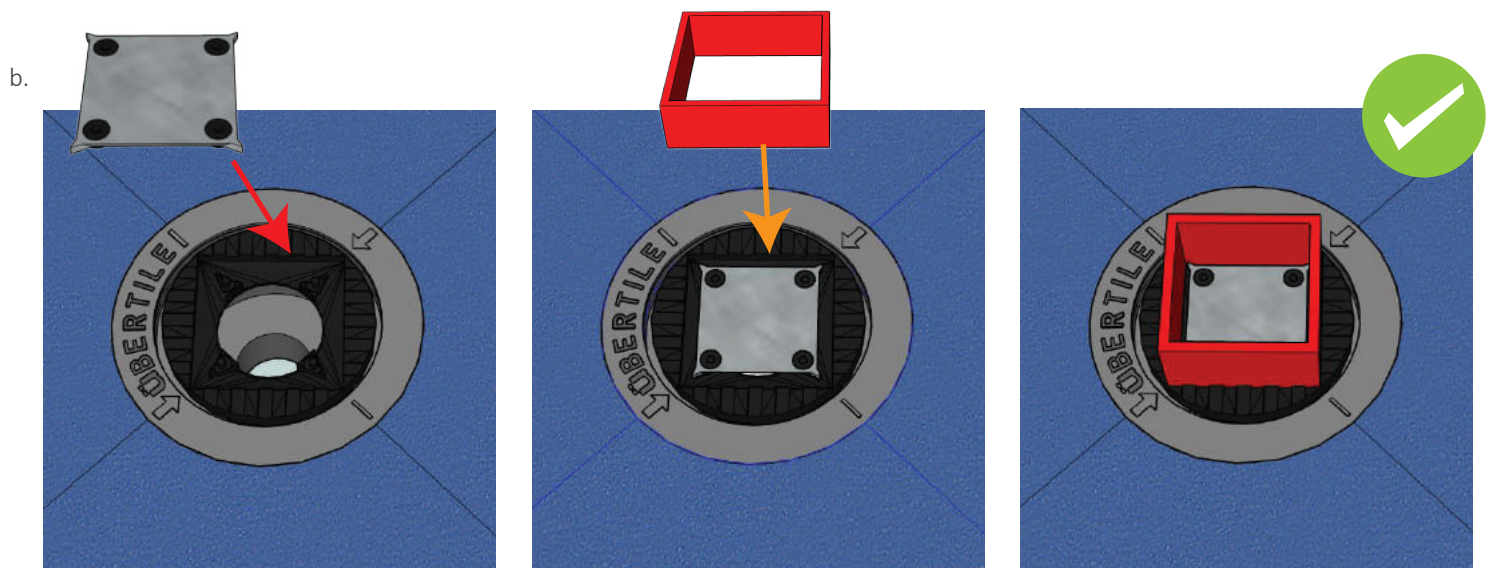

The **Tileable Drain Grate** is placed onto the **Tileable Grate Holder** , by aligning the 4 holes of the **Grate** with the 4 posts of the **Grate Holder** , pressing firmly into place until fully seated.

Place the **Grout Joint Spacer** into position.

2.52P - Installation of Tileable Drain Grate

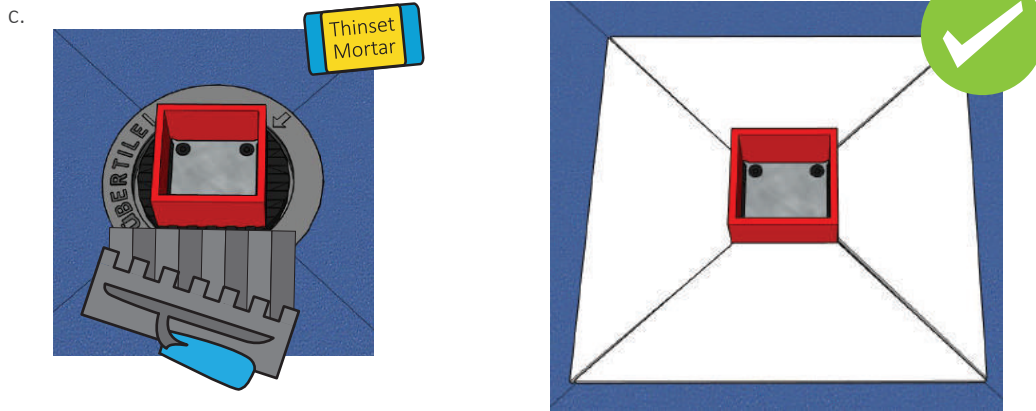

Install Tile onto the **Presloped Shower Pan**, tiling upto the **Grout Joint Spacer**.

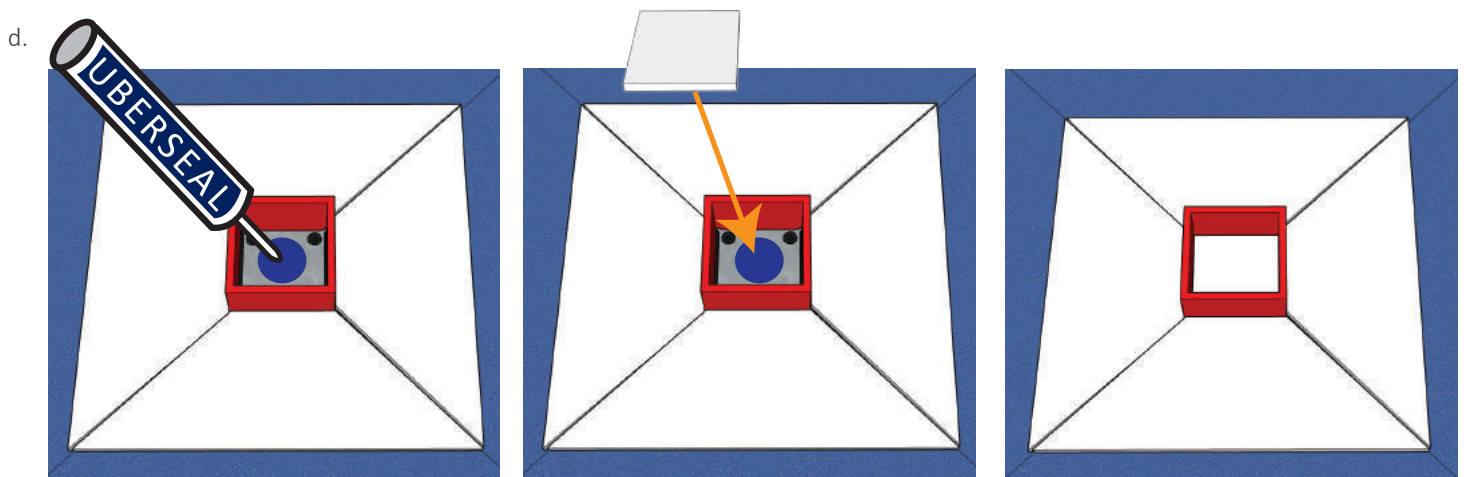

Apply **Uberseal™** to the top of the **Tileable Drain Grate**.

Apply **Uberseal™** to the backside of the Tile being installed onto the **Tileable Drain Grate**.

With the **Uberseal™** still fresh, install the Tile onto the **Tileable Drain Grate**, ensuring the **Uberseal™** has full coverage on the backside of the Tile. Temporarily remove **Grout Joint Spacer**, to ensure no **Uberseal™** has oozed out, otherwise it will make removing the **Grout Joint Spacer** very difficult.

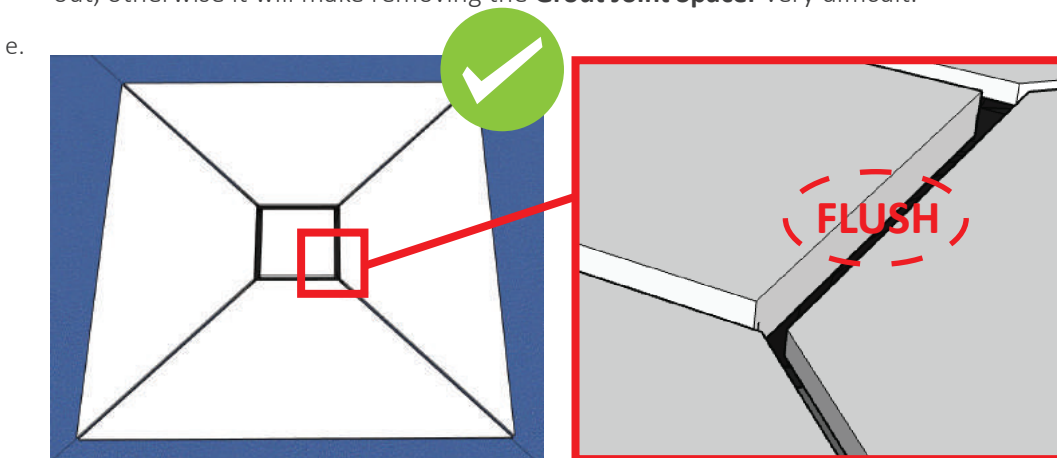

With the **Uberseal™** still fresh, remove the **Grout Joint Spacer** & ensure the Tile on the **Drain Grate** is evenly spaced and **FLUSH** with the tile on the **Presloped Shower Pan**.

Once the **thinset** has cured, you may reinstall the **Grout Joint Spacer** to aid in grouting, to ensure no grout falls into the void at the **Tileable Drain Grate**.